

iquatics®

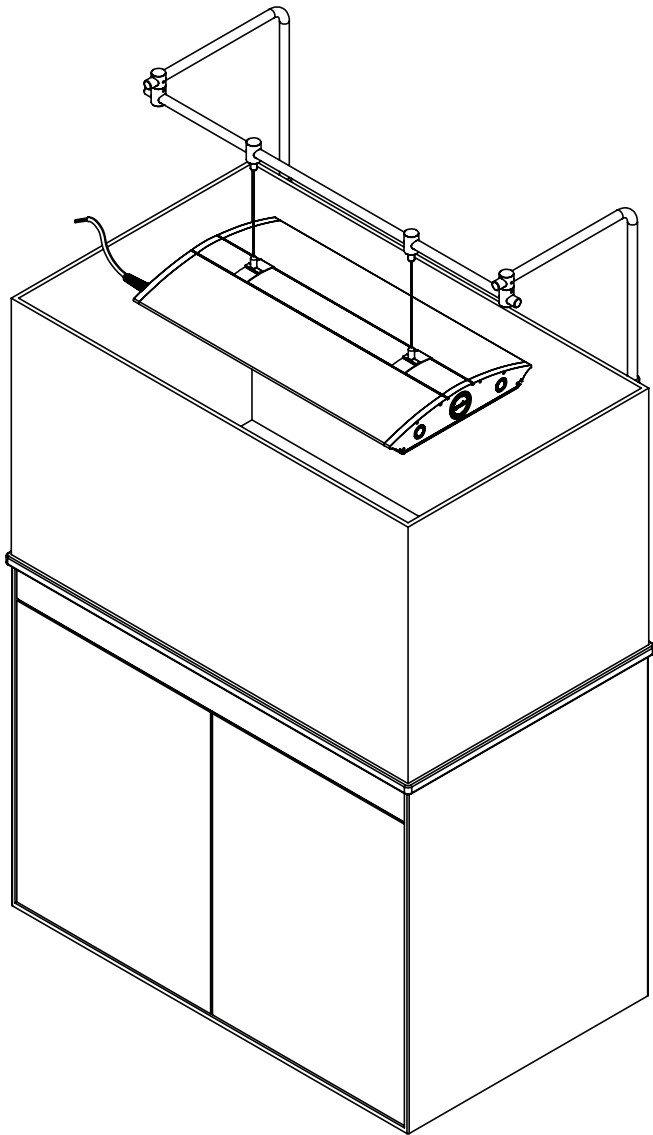

Universal Aquarium Light **HANGING SYSTEM**







STAINLESS STEEL

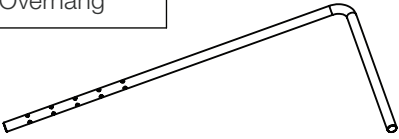

iQuatics Hanging Bar System – Disclaimer

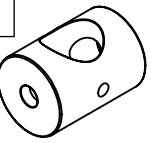
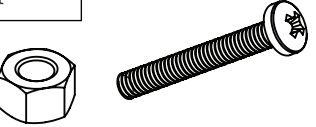
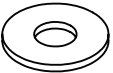
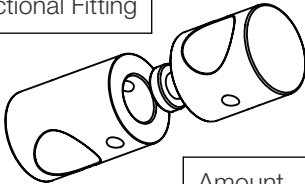
Please ensure that the iQuatics Hanging Bar system is securely fixed in the position you require. As each aquarium setup is different it is down to the customer to make sure the connection to your aquarium or wall is adequate enough to withstand the weight of the item being suspended. iQuatics cannot be held responsible for any damage that may occur through the improper fitting of the iQuatics hanging bar system. Please ensure all grub screws are fully secured prior to the installation of the lighting system, iQuatics highly recommends the load weight is tested before attaching your pendant.

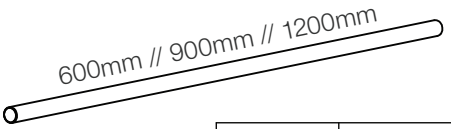
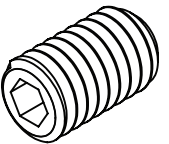
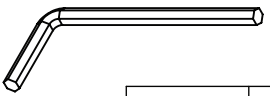
Components

L-Overhang		A	Support Bar		B
Amount	2		Amount	2	
Wall/Tank Attachment		C	Nut & Bolt		C
Amount	4		Amount	4	
Washer		C	Directional Fitting		D
Amount	8		Amount	2	
Suspension Fitting		E	Cross Bar		F
Amount	2		Amount	1	
Grub Screw		G	Allen Key		H
Amount	12		Amount	2	
E-Clip		I	Anti-Rattle Ring		J
Amount	2		Amount	2	

REAR MOUNTING

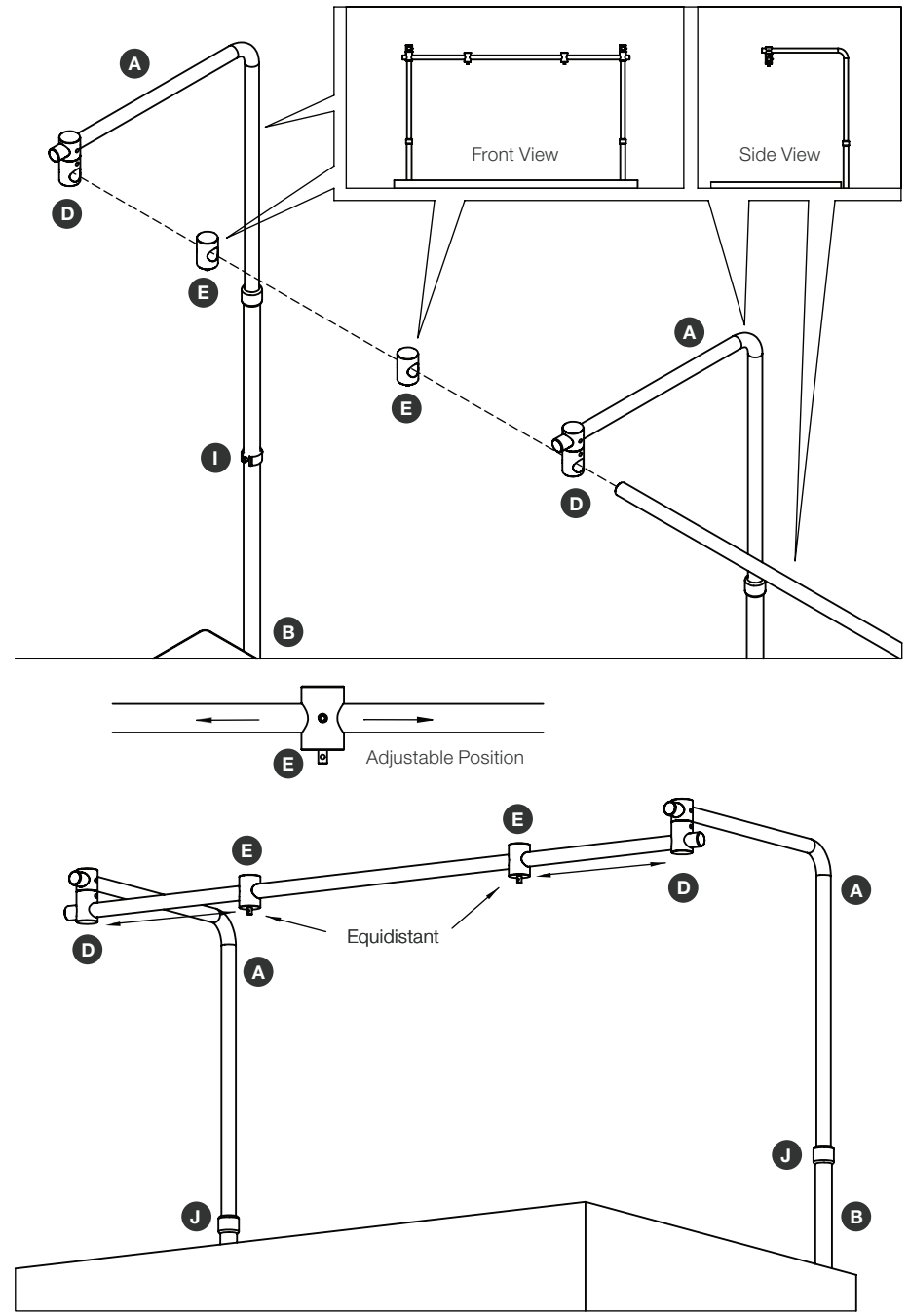
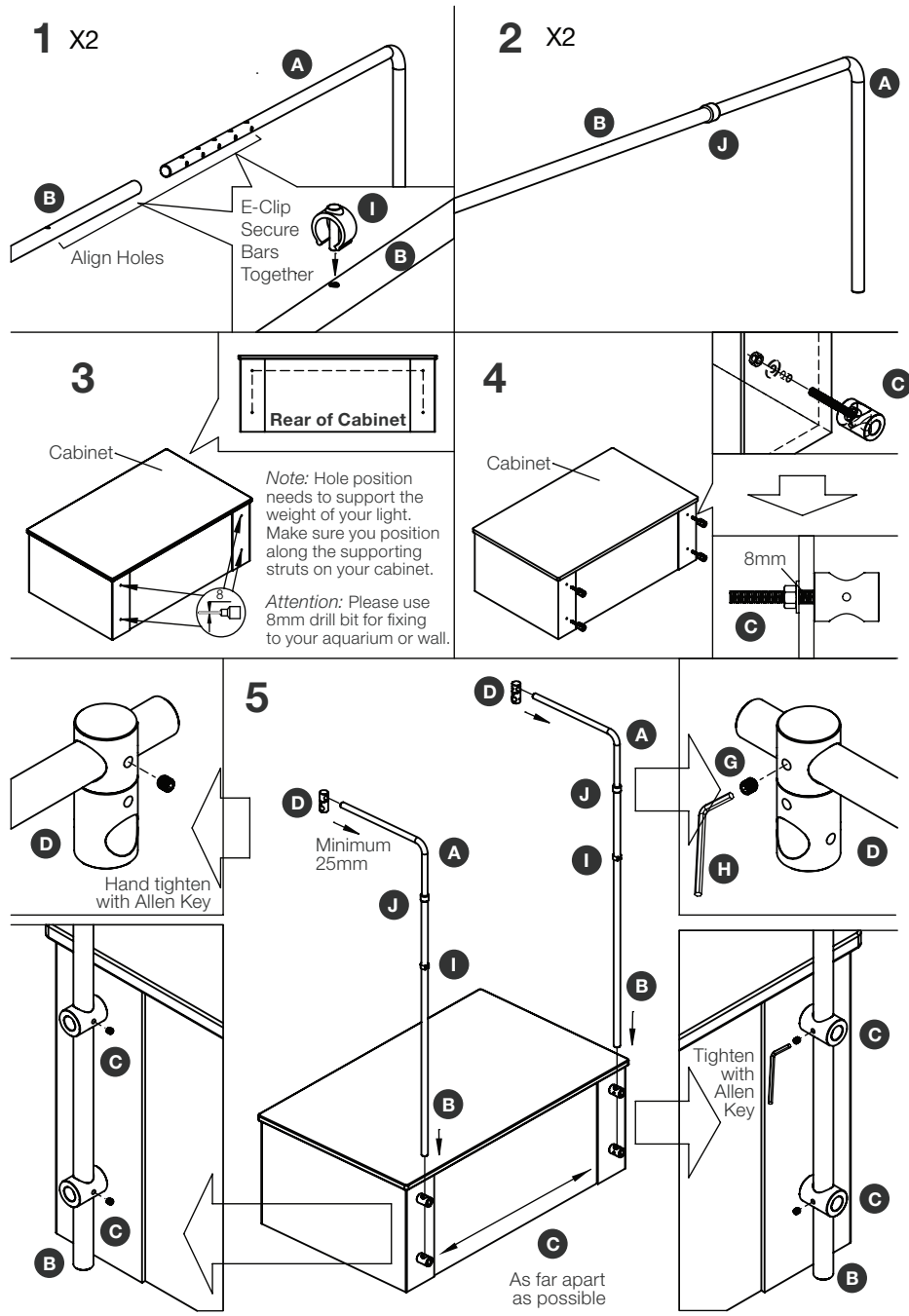

SIDE MOUNTING

